

Bromex



Vicon Flail Chopper Range



My way of Farming!

BROMEX - THE PROFESSIONAL FLAIL CHOPPERS

My way of Farming!



Working the land, running my farm and connecting with nature. Farming is my way of living, and despite being rough at times, I never grow weary of everyday tasks of attending to my land and livestock. I keep up with developments by staying loyal to personal philosophies and applying the appropriate strategy.

I shape and influence my own future by combining craftsmanship with modern technology, employing the very best machinery. I actively seek new opportunities, by being innovative in my way of working. I work hard to grow a good crop. I am passionate about my livestock, providing my animals with only the best. My farm and its returns, reflects who I am, because my heart and soul is put into the work I do.

Farming is about passion, about growing and developing, my crop, my farm, myself, my way.

Flail Chopper Range Overview

What are the requirements for your job?

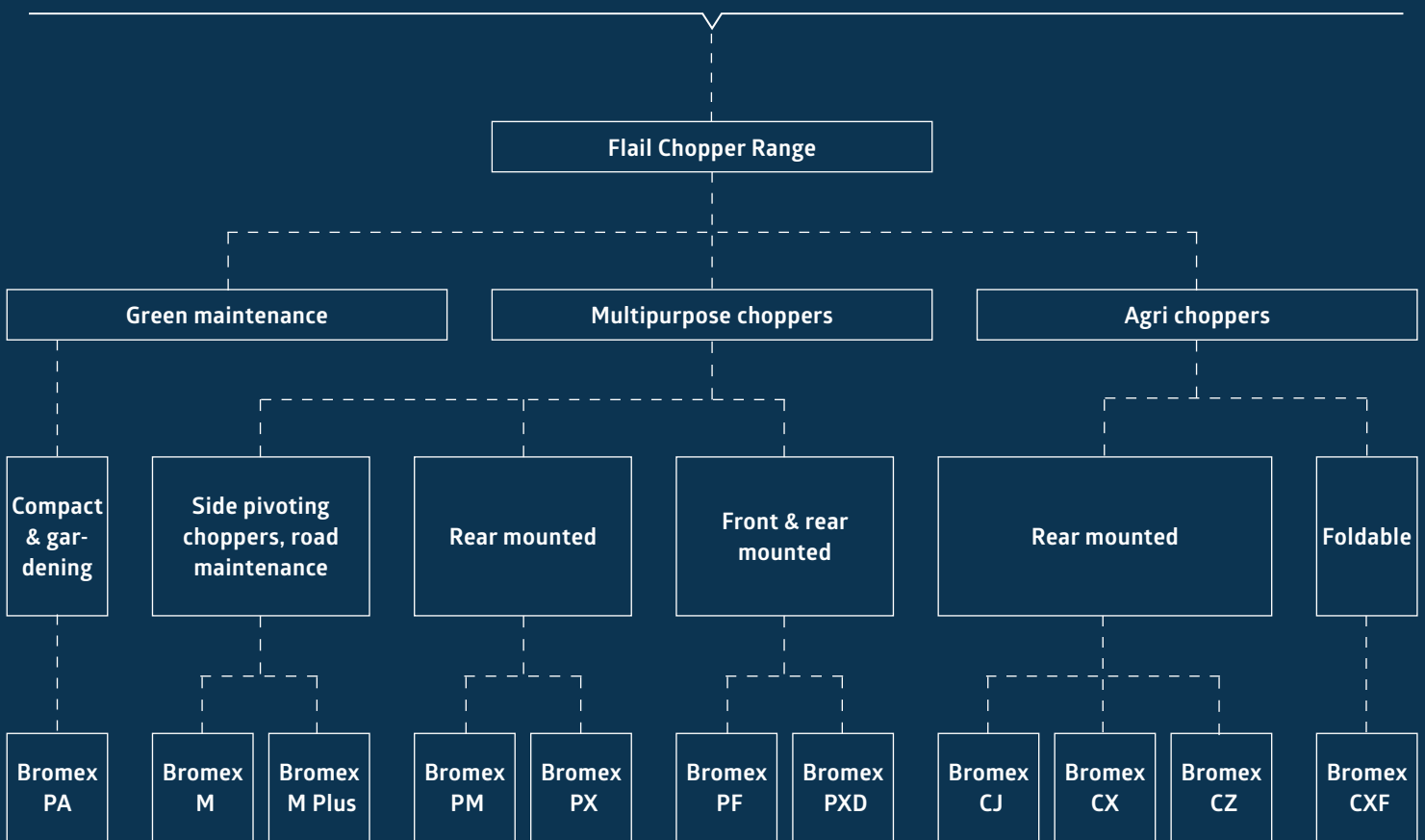

GREEN AREA AND SPECIALITY CROPS FLAIL CHOPPERS



Green maintenance

Compact &
gardening

Bromex
PA



**Green Area and and speciality crops Choppers
(Bromex PA)**

1.50-1.80m working width

Whether your requirement is for maintenance between rows in vineyards and orchards or the routine maintenance of grass in parks and other amenity areas, regular cutting is an essential task.

Efficient and environmentally friendly upkeep of these areas, either with a close cut for amenity purposes, or higher cutting for routine maintenance requires a machine with closely spaced flails and high rotor speeds. This ensures the finest cut quality, whilst efficient mulching of crop residues facilitates rapid decomposition of residues for that perfect finish.

Vicon Bromex PA choppers with their low power consumption and minimal maintenance requirement means that it has never been so easy to keep these areas attractive and tidy.

Green Area and Crops Flail Choppers

Compact Size

“**Low power requirement and minimal maintenance**”



Perfect ground following thanks upper and lower floating links

Stable transmission with 3 V-belts and fixed tensioner

Double skids for easy maintenance low operating costs



Category 1 headstock with floating lower and upper links.



All gearboxes on Vicon choppers range feature as standard an integrated free wheel.

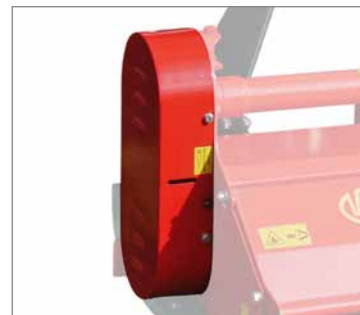

Belt transmission with simple tension system.



Two different headstock positions leave a possible mechanical offset at customer choice

Light but robust body fits best small tractors and heavy work

Maintenance free bearing large diameter roller for nice work height control



High rotor speed and universal blades offer best results for grassland maintenance and stubble chopping.

Dynamic balanced rotor for precise quality and lowest noise on vibration level.



135mm diameter ground contour roller with integrated scrapper.



“ **Small tractor matching**
– up to 50hp”

The Specialist *for Green Areas*

Compact Size – Easy to Operate

The Vicon Bromex PA grass chopper is a small, medium duty machine suited to operation use on slightly rough ground, green areas amenity areas, and tidying up pasture. It is available in two models with working widths of 1.50m and 1.80m, is very easy to operate and requires minimal maintenance.

As well as the universal blades fitted as standard, cup blades can also be fitted on request. The Bromex PA is suitable for tractors up to 50hp and it is the perfect choice for green areas.

The core of the Bromex PA chopper is the rotor: fast rotation speed (2052 rpm) in combination with a high number of blades per meter give the Bromex PA a superb chopping performance.

As standard, the Bromex PA offers a mechanical offset: at customer convenience, the headstock can be fitted in the centre or on the left side of the chopping unit.

The Bromex PA is equipped as standard with a rear roller and skids which allows reliable cutting height control.





The cutting and shredding of crop residues has multiple agronomic benefits in a wide variety of situations, making the chopper a true multi-purpose tool. Whether in roadside maintenance, pasture land, headland management of field borders or between crops on arable or fallow land, efficient shredding of residues is an essential tool in good crop husbandry.

The chopping and shredding of excess vegetation is an environmentally friendly way to control unwanted growth. Grass thrives by being cut and the resultant new growth is more appealing for animals to graze.

With the increasing use of minimal tillage systems for crop establishment, intensive shredding of crop residues or cover crops has become increasingly important. It promotes quick and efficient breakdown and aids reabsorption of organic matter back into the soil, thus improving soil structure and fertility. In these environmentally sensitive times it has also become more desirable than ever to avoid the use of chemicals wherever possible.

MULTIPURPOSE FLAIL CHOPPERS

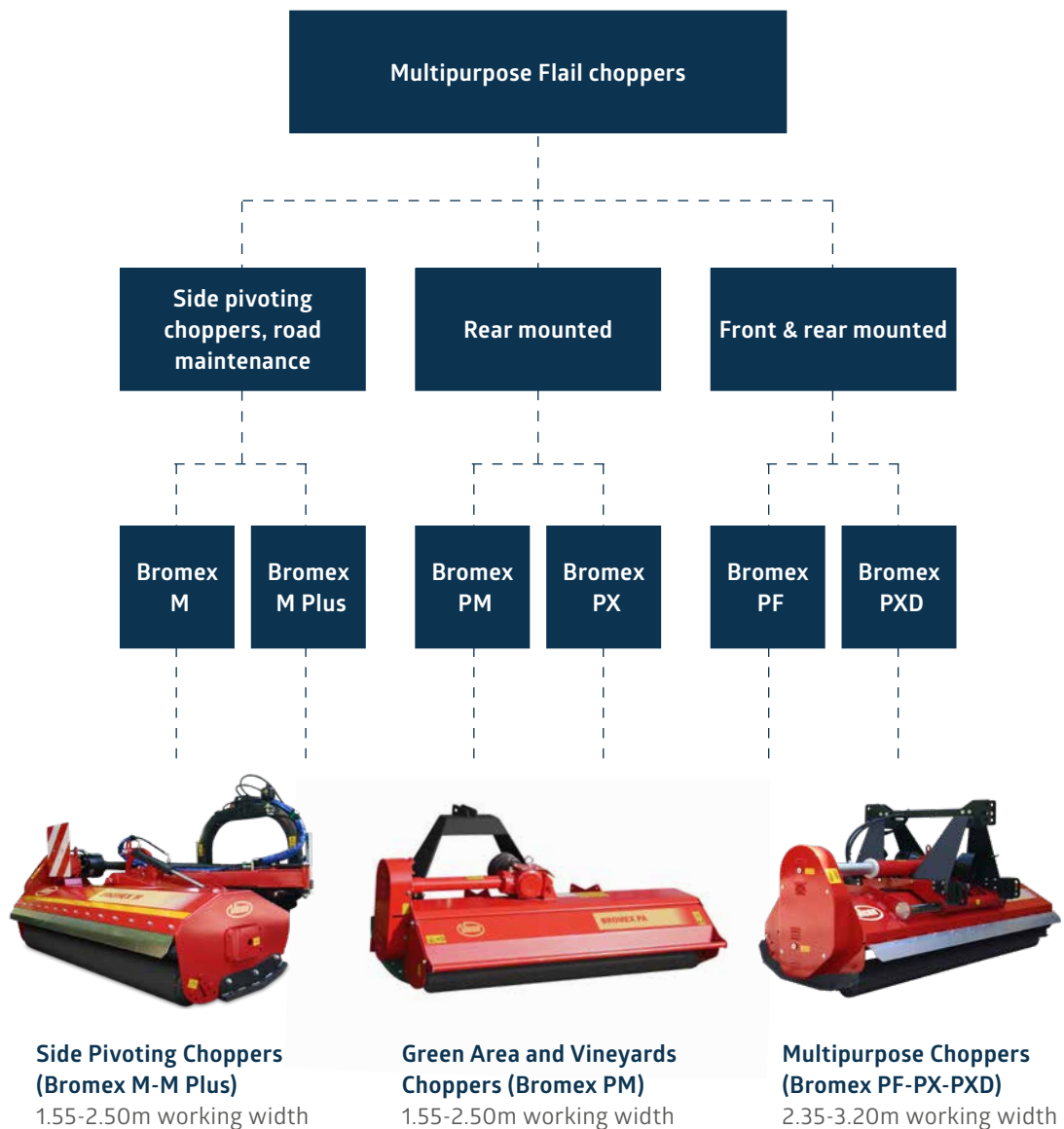

Multipurpose Flail Choppers

Easy Operation

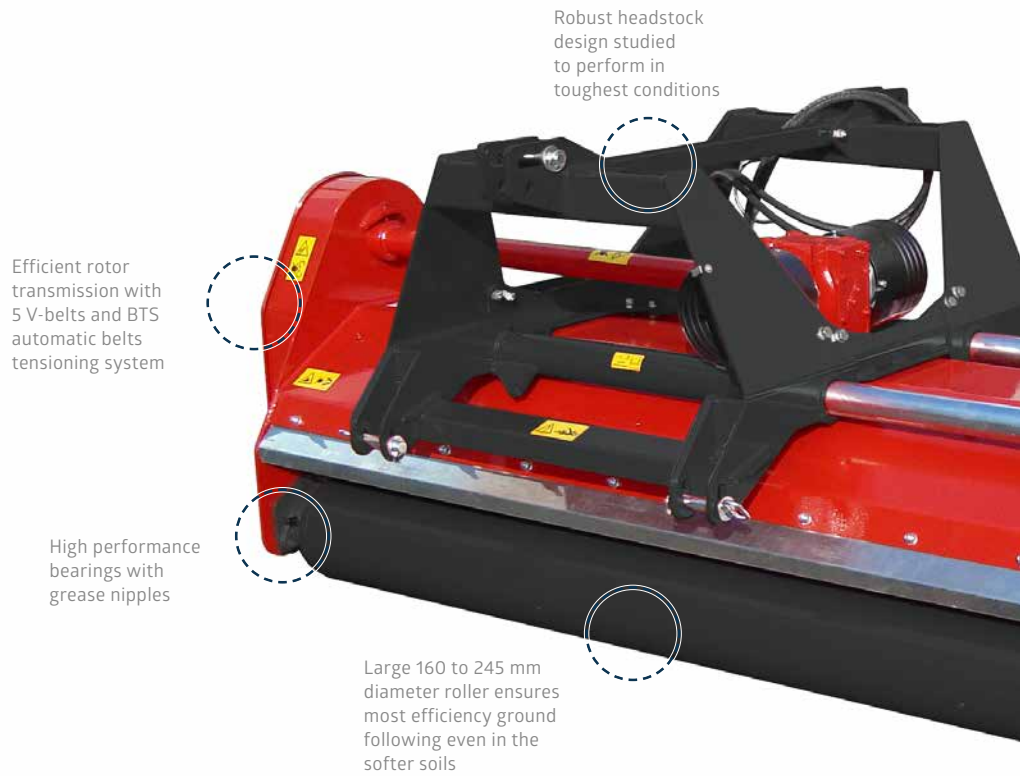

A strong offset headstock ensures best performances over long lifetime. Bromex PF / PXD offer also front linkage solution.



All gearboxes on Vicon choppers range feature as standard an integrated free wheel.



BTS automatic belt tensioner ensures a stable rotor transmission in all working conditions.

Easy operation and versatility thanks to the side shift feature (hydraulic as option)

Robust frame built for the roughest conditions integrated with a counter knife as standard

Standard bolted skirts offer unique wearing plate that simplifies replacement and lowers maintenance costs

“**Compact but robust**
- superb manoeuvrability”

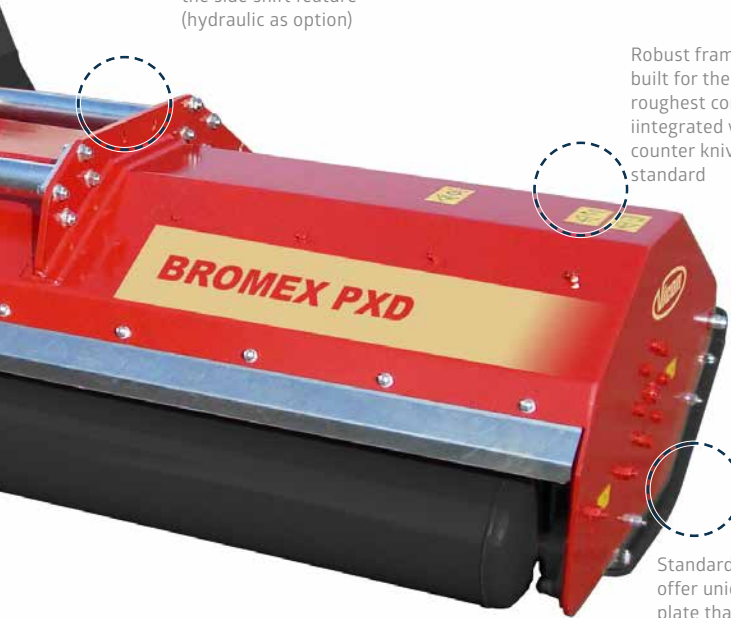

High linear tip speed and significant number of blades always ensure the best chopping results with all material type.



The 160mm big diameter roller with self cleaning system fitted as standard to maximise the field performances.

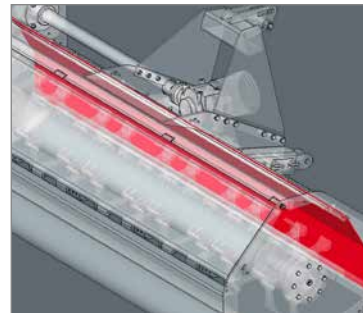

A number of optional accessories such a second counter knife or double skin are available for further customisation according to the needs.



More offset – *More versatility*

The Vicon Bromex M (and its tall brother Bromex M Plus) are multipurpose choppers for road maintenance, clearing out field edges, ditches and hedges. In addition they show versatility in operation on grass, light wood and bushes thus being ideal for the maintenance of parks, gardens and road sides.

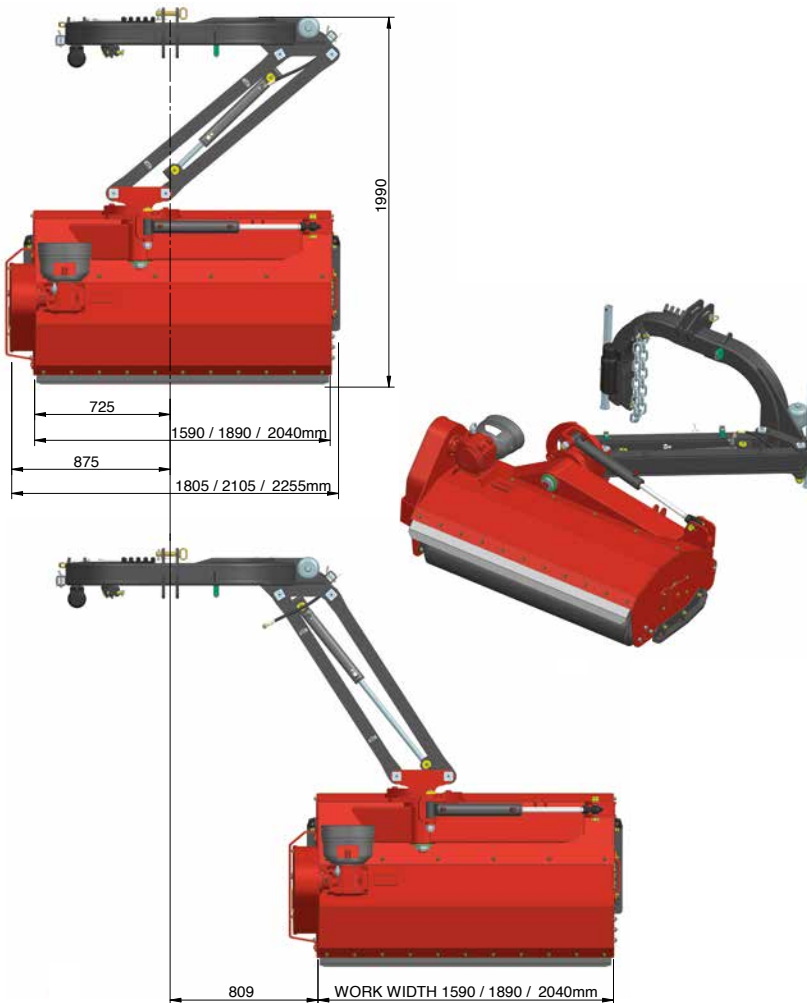

Tilting angle of -65 degrees.



Maximum versatility - Horizontal cutting.



Vertical cutting.

Offset articulation

Different offset positions can be reached by different working widths. Versatile in all conditions due to extremely efficient articulation (-65° & +90°).



Efficient working *in all conditions*

Compact and easy

Due to the possibility of different working angle positions, the Bromex M (Plus) is a highly versatile solution for farm and road maintenance purposes. Compact but robust these choppers offer superb manoeuvrability and provide a high level of reliability.

Compared to the standard Bromex M chopper, the plus version offers greater offset (1255mm) and reaches positions and working angles impossible to get with other machines. In addition the Bromex M Plus can be combined with a front mounted chopper (Bromex PF or Bromex PXD), to maximise working width.

Lateral transmission

The rotor is powered by a powerful transmission gearbox with integrated freewheel and five belts which incorporate an automatic tensioner, provide stable rotor speed even when working in tough conditions. A PTO shaft with wide angle joint is fitted as standard equipment.



Robust and guarded

Main frame and parallelogram articulation are designed for intensive use and extreme demanding conditions; heavily tested in our dedicated Kverneland Group laboratories to ensure reliable and long working life. Gearbox and transmission are protected against misuse during operation.

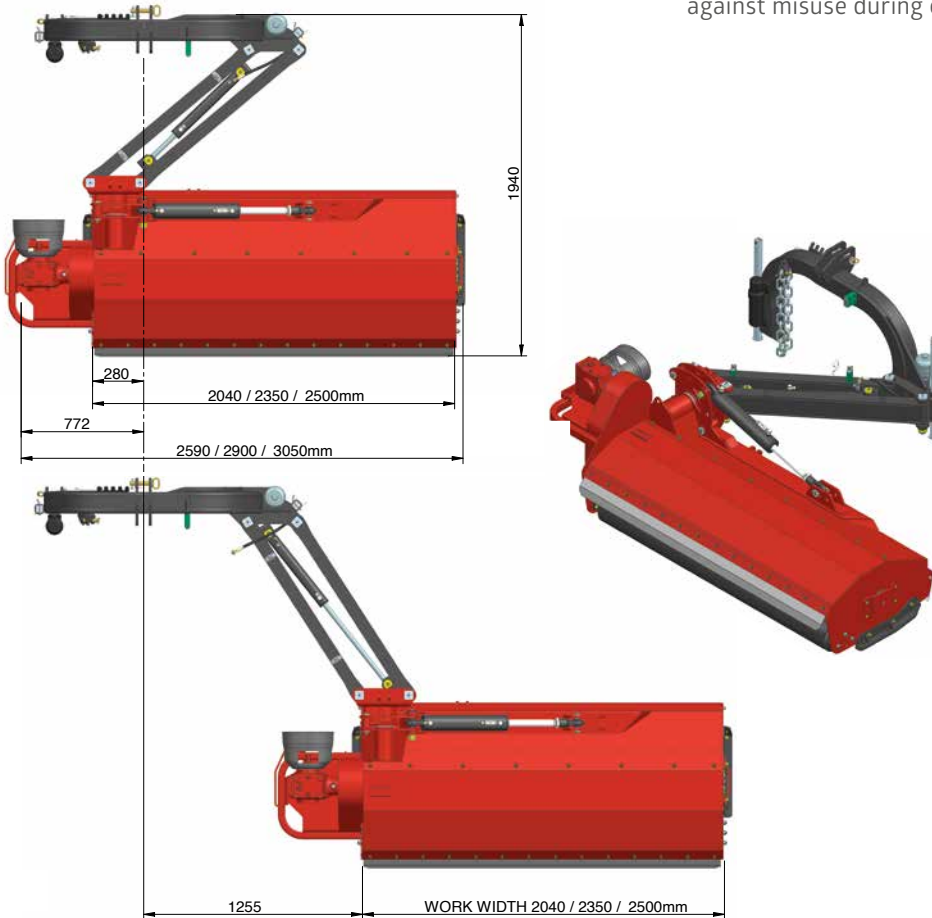

Offset articulation

Different offset positions can be reached by different working widths. Versatile in all conditions due to highly efficient articulation (-65° & +90°).



Efficient *and Durable!*

Compact heavy duty machine

The Vicon Bromex PM is a compact and heavy duty chopper for moderately demanding jobs in soft grounds top fruit orchards, vineyards and light undergrowth. It is also equally fitting for tidying pasture and other grass fields, chopping straw and stubble.

Due to its rugged construction the Bromex PM ensures a long lifetime with minimal maintenance. Adjustable headstock offset up to 500mm adds versatility for reaching under fruit trees and safer working close to the edges of drainage channels.

“**Excellent shredding effect with minimal power requirement**”

As an option, the hydraulic adjustment of the offset can be specified. In addition the standard roller and the skids support the chopper and provide a consistent working height.

Modern and versatile

The design of the Bromex PM is modern and versatile; the latest generation rotors can be equipped with different types of blades, making them adaptable to most conditions. The highest rotor speeds (2160rpm) in combination with a counterknife and a frame integrated double skin, guarantee an excellent shredding effect with minimal power requirement.



The Vicon Bromex PM can be equipped with rake tines to improve chopping on prunings.

Versatile *and Reliable*

The Vicon Bromex PX is a multi-purpose machine for chopping grass, pasture, set-aside land and stubble. The hydraulic offset facility gives you the possibility to clear out field edges, orchards and road edges. A choice of hammer blades or universal Y blades with short fan blades produce perfect shredding quality in all conditions.



Performance

A massively strong tube with dimensions of 245 x 10mm forms the basis of the rotor. The large overall working diameter of the rotor guarantees an excellent cut and chopping effect. The counterknife and the double skin are suggested for a finer shredding of residues and a longer working life of the frame. Skids and a roller are standard equipment and provide accurate control of working height. The roller has a 245mm diameter and is self-cleaning (thanks to the blades running close to the roller profile).

Low power requirement

With an offset facility of up to 52cm the Bromex PX range is the ideal solution for field and farm maintenance. In addition the large dimension of the cutting unit (540mm) guarantees excellent cut quality with low power requirement. Easy and minimal maintenance make the Bromex PX a cost effective machine to operate.

Frame

The headstock is designed and tested for heavy applications with all forces and stress concentrated on the three point linkage.

Transmission

Central gearbox with an integrated free wheel as standard complies with the heavier operations. The drive pulleys are reversible allowing for operation with either 540 or 1000rpm input speed. Five grooved V-belts combined with an automatic tensioner ensure smooth power transmission. No maintenance required.





Front, Rear, *Offset!*

Versatile - for chopping grass, pasture, set-aside land and stubble

A strong double headstock allows mounting the machine in front or behind the tractor. Together with an hydraulic offset facility, it gives multi purpose versatility for nearly all conditions e.g. clearing out field edges, orchards, road edges. Available with hammer blades or universal fan blades.

Lateral Drive

Bromex PF is driven by five VX type V-belts running on invertible pulleys which allows adaptation for 540 or 1000rpm drive. The idler wheel with automatic tensioner spring always ensures stable and low wear on belt drive while offering the safety that is needed to protect the machine from over-usage.



Auto-alignment

The central gearbox fitted into the headstock ensures that the pto-shaft remains at the same angle in all working positions. Even on max. 500mm offset the pto angle does not change. This guarantees a smooth drive, reduced wear and a longer lifetime of the pto shaft and the whole driveline (crosses and yokes).



**“ Smooth drive,
reduced wear
- longer lifetime ”**

Hydraulic Offset

Ideal for clearing out field edges or road maintenance. The precisely aligned offset frame of the machine after the welding process ensures strong and reliable guidance. Greaseable nylon bushes ensure a long lifetime.



Versatility *combined with efficiency*

Double headstock allows front or rear mounting of the Bromex PXD. Thanks the sliding tube integrated in the headstock, all forces are concentrated on the three point linkage. It has standard fit 52cm hydraulically operated offset facility and a central gearbox rated up for resisting the hardest conditions with double integrated free wheel as standard. The drive pulleys are reversible allowing for operation with either 540 or 1000rpm input speed.





Front mounting.

“ *Sliding tubes are integrated in the headstock* ”



Double headstock.

Robust Transmission

Five V-belts combined with an automatic belt tensioner ensures smooth power transmission, preventing slippage in the toughest working conditions.

No maintenance is required. The double headstock allows front or rear mounting of the Bromex PXD. Sliding tubes are integrated in the headstock; all stress is concentrated on the three point linkage. It has standard fit 52cm hydraulically operated offset facility.



Efficient shredding of crop residues can be considered as a valuable addition to soil fertility and an essential tool in the promotion of good crop husbandry. With the increasing use of minimal tillage systems for crop establishment, the intensive shredding of crop residues or cover crops has become increasingly important. It is essential to promote a quick and efficient breakdown, aiding reabsorption of organic matter back into the soil, thus improving soil structure and fertility.

In large scale operations, especially where residues can be mature or bulky, the requirement is for a chopper with a wider working width and which is built to withstand the rigours imposed by use on higher horsepower tractors under intensive working conditions.

AGRI FLAIL CHOPPERS

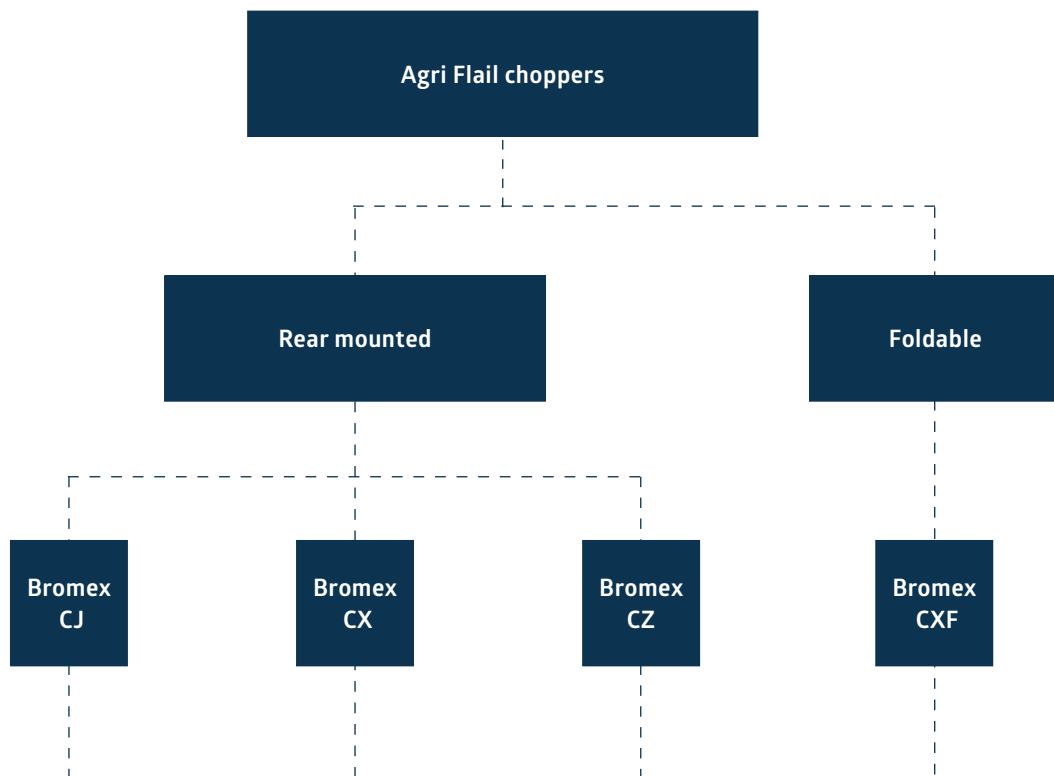

**Agri Choppers
(Bromex CJ)**
2.80m working width



**Agri Choppers
(Bromex CX)**
2.80-3.20m working width



**Agri Choppers
(Bromex CZ)**
3.20-4.00m working width



**Agri Choppers
(Bromex CXF)**
5.60- 6.40m working width

Agri Flail Choppers

Suitable for Different Crops

“**Range of accessories**
- to fulfill all
operating
requirements”



A strong headstock ensures a long lifetime even on the heavy duty chopper bodies.



All gearboxes on Vicon choppers range feature an integrated free wheel as standard.



The transmission of the agri-chopper range is designed for maximum power transfer and minimal maintenance.



Special hammer design or fan or universal blades create a suction effect lifting material and improving cutting.



Best ground following and field cleaning is achieved by using either back roller or wheels according to soil type.



A number of optional accessories such as second counter knife or double skin are available for further customisation according to the needs.





Excellent performance – *low operating costs*

An agri chopper suitable for different crops

The Vicon Bromex CJ is an agri chopper suitable for grassland renewal, maize, sunflower and sorghum shredding. The frame of the chopping unit is designed with a curved profile for improved crop flow and output, while the rear cover can be opened to ease the access to blades and rotor for maintenance. In addition, the high chopping chamber guarantees blockage free performance even in the toughest conditions.

The roller bearings are integrated and protected and do not need regular greasing. The semi-pivoting wheel kit is also maintenance free. A double skin and a second counter knife can be added as accessories in order to extend the life of the chassis and create finer chopped residues.

The Flail Chopper *for Specialists*

Great versatility in all conditions! The Bromex CX range comprises Vicon's largest and toughest grass and straw choppers built for heavy-duty work on set-aside land and cultivated fields. It is also suited to fruit farms, clearing scrub and tidying pasture. The Bromex CX is available in 2 working widths to cover various requirements.



**Versatility and high field performances**

Vicon Bromex CX choppers offer unique operational versatility. The high rotor speed combined with a large number of blades and big diameter of the cutting unit increases the cutting efficiency while reducing the input power required. The rotor is manufactured precisely and is dynamically balanced after the blades have been fitted; this provides smooth running without vibration.

“**Heavy construction**
– for reliable
operation”

Range of accessories

The Bromex CX can be equipped with different blade types in order to fulfill all operating requirements. Skids are included in the standard configuration. Wheels are optionally available. Furthermore a double skin and second counterknife are also optionally available. However, all models are solidly constructed with a robust gearbox and very strong power transmission to the “V” belts driving the rotor. In addition, a strengthened chassis incorporates double plating in the areas subjected to highest stress.

The combination of Vicon’s precisely manufactured rotor shafts and hard wearing blades makes the Bromex CX models extremely reliable.



Vicon Bromex CZ – *the King of the Flail Choppers!*

More than 40 years experience

The Vicon Bromex CZ range has been designed to fulfill the most demanding requirements and to provide maximal chopping of crop residues for more effective decomposition.

The development of these choppers was focused on the requirements of intensive users. They are ideal for very demanding and specialized contractors. The Bromex CZ is excellent for shredding crop residues, chopping straw, maize and sunflower stalks as well as set-aside land.

The Bromex CZ is always equipped with a double lateral transmission. External and centralized greasing points for the rotor ensure a quicker maintenance.



Semi pivoting wheels

Semi pivoting wheels (10/8.0 x 12.8 ply) as standard ensure good stability and a constant working depth of the Bromex CZ during field operations.

Semi automatic linkage (Cat III) allows fast coupling of Bromex CZ. In addition the floating top link mounting permits easy control of the working height without stressing the headstock.

Rotor

The same rotor can be equipped with either Y blades or hammer blades; in all configurations special fan blades lift the material up for a better shredding effect. The large diameter (760mm) guarantees an excellent cut with low power requirement.





High Performance *Potential*

High performance rotor for excellent shredding in all conditions

The Bromex CXF foldable is particularly suitable for tractors up to 260hp, with working widths from 5.60 to 6.40m. Wide in the field - narrow on the road.

Despite the wide working width the Bromex CXF folds to 2.50m transport width.



Transport width 2.50m.

The highly efficient rotor, which works at a speed of 2025rpm ensures excellent chopping in all conditions, thanks to its diameter of 540mm and 144 fitted blades. High rotor speed in combination with a counterknife and an eventual optional double skin guarantees an excellent shredding effect with minimal power requirement.

The lateral transmission with five V-belts tensioned via the BTS automatic belt tension system is allowing stable power supply to the cutting elements.

Available as option are pivoting wheels or rollers that guarantee a constant working height.

The Bromex CXF offers maximum reliability, efficiency and versatility. This is the result of 40 years of Vicon experience in building choppers that suits each user profile and needs.

“**Maximum reliability, efficiency and versatility**”



The central gearbox is equipped with free wheels; the lateral transmission with automatic belt tensioners ensures reliability and a low maintenance requirement.



Working width from 560 to 640cm. The standard roller (Ø245mm) is running close to the profile to ensure a self-cleaning effect.



Semi pivoting wheels (10/8.0 x 12.8 ply) available as option ensure good stability and a constant working depth during field operation.

Original Parts & Service

We are here so you can focus on your crop

- 
- 1 Long lasting, high quality spare parts**
 - 2 Over 100 years of parts knowledge**
 - 3 Support from a wide network of dealers**
 - 4 24/7 spare parts service**
 - 5 Highly skilled dealer technicians**



“**MYVICON**
Connected farming, my way”

A personalised online platform tailored to your machine needs

With MYVICON you will benefit from easy access to Vicon's online service tools. Receive first hand access to information on future developments and updates, operator and spare part manuals, FAQs and local VIP offers. All information is gathered in one place.



**REGISTER YOUR PRODUCT NOW:
MY.VICON.EU**

Facts

Model	Flail Choppers for Green Area and Speciality Crops		Side Pivoting Flail Choppers					
	Bromex PA		Bromex M			Bromex M Plus		
Dimensions & Weight								
Working width (cm)	150	180	155	185	200	200	230	250
Transport width (cm)	170	200	180	210	225	255	285	305
Weight (kg)	300	335	740	780	820	900	960	985
Attachment to Tractor								
Pto input speed (rpm)	540	540	540	1000	1000	1000	1000	1000
Min-Max. power requirement (hp)	30 - 50	30 - 50	45 - 100	45 - 100	45 - 100	70 - 130	70 - 130	70 - 130
Operation								
No. of universal blades	80	96	40	48	52	52	60	64
No. of hammer blades	-	-	20	24	26	26	30	32
Rotor speed (rpm)	2052	2052	1800	1800	1800	1858	1858	1858
Blade tip speed (m/s)	40	40	43	43	43	44	44	44
Rotor shaft diameter (mm)	40	40	50	50	50	50	50	50
Rotor diameter (mm)	102	102	169	169	169	169	169	169
Cutting diameter (mm)	376	376	452	452	452	452	452	452
No. of belts	3	3	5	5	5	5	5	5
Belt tensioner	manual	manual	automatic	automatic	automatic	automatic	automatic	automatic
Equipment								
Offset (mm)	-	-	580	580	580	1250	1250	1250
Rear roller (mm)	135 ●	135 ●	195 ●	195 ●	195 ●	195 ●	195 ●	195 ●
Rear wheels	-	-	-	-	-	-	-	-
Skids	●	●	●	●	●	●	●	●
I counter knife	-	-	●	●	●	●	●	●
II counter knife	-	-	0	0	0	0	0	0
Double skin	-	-	●	●	●	-	-	-

● Standard 0 Optional - Not available

Model	Multipurpose Flail Choppers							
	Bromex PF		Bromex PX			Bromex PXD		
Dimensions & Weight								
Working width (cm)	235	280	325	235	280	320	280	320
Transport width (cm)	255	300	345	255	300	345	300	345
Weight (kg)	863	980	1080	1025	1135	1225	1220	1380
Attachment to Tractor								
Pto input speed (rpm)	540 or 1000	540 or 1000	540 or 1000	540 or 1000	540 or 1000	540 or 1000	540 or 1000	540 or 1000
Min-Max. power requirement (hp)	95 - 140	95 - 140	95 - 140	100 - 160	100 - 160	100 - 160	100 - 160	100 - 160
Operation								
No. of universal blades	40	48	56	56	72	80	72	80
No. of hammer blades	20	24	28	28	36	40	36	40
Rotor speed (rpm)	1730 - 1828	1730 - 1828	1730 - 1828	1844 - 1949	1844 - 1949	1844 - 1949	1844 - 1949	1844 - 1949
Blade tip speed (m/s)	46 - 48	46 - 48	46 - 48	52 - 55	52 - 55	52 - 55	52 - 55	52 - 55
Rotor shaft diameter (mm)	60	60	60	60	60	60	60	60
Rotor diameter (mm)	220	220	220	245	245	245	245	245
Cutting diameter (mm)	503	503	503	541	541	541	541	541
No. of belts	5	5	5	5	5	5	5	5
Belt tensioner	automatic	automatic	automatic	automatic	automatic	automatic	automatic	automatic
Equipment								
Offset (mm)	500	500	500	550	550	550	550	550
Rear roller (mm)	195 ●	195 ●	195 ●	245 ●	245 ●	245 ●	245 ●	245 ●
Rear wheels	0	0	0	-	-	-	-	-
Skids	●	●	●	●	●	●	●	●
I counter knife	●	●	●	●	●	●	●	●
II counter knife	0	0	0	0	0	0	0	0
Double skin	0	0	0	0	0	0	0	0

● Standard 0 Optional - Not available

Flail Choppers for Green Area and Vineyards

Bromex PM

155	185	200	230	250
177	207	222	252	272
475	540	572	620	655
540	540	540	540	540
60 - 80	60 - 80	60 - 80	60 - 80	60 - 80

40	48	52	60	64
20	24	26	30	32
2160	2160	2160	2160	2160
51	51	51	51	51
50	50	50	50	50
169	169	169	169	169
452	452	452	452	452
5	5	5	5	5
automatic	automatic	automatic	automatic	automatic

500	500	500	500	500
160 ●	160 ●	160 ●	160 ●	160 ●
-	-	-	-	-
●	●	●	●	●
●	●	●	●	●
0	0	0	0	0
●	●	●	●	●

Agri Flail Choppers

Bromex CJ Bromex CX Bromex CZ Bromex CXF





280	280	320	320	400	560	640
300	302	342	352	432	250	250
940	1174	1302	1750	2200	2400	2700

540 or 1000	540 or 1000	540 or 1000	1000	1000	1000	1000
75 - 130	100 - 160	100 - 160	100 - 260	100 - 260	130 - 260	130 - 260

68	72	80	120	152	144	160
34	36	40	60	78	72	80
1789 - 1887	1844 - 1949	1844 - 1949	1603	1603	2025	2025
56 - 59	63 - 66	63 - 66	64	64	57	57
45	60	60	60	60	60	60
194	245	245	273	273	245	245
600	651	651	767	767	541	541
5	5	5	2 x 4	2 x 4	2 x 5	2 x 5
manual	automatic	automatic	manual	manual	automatic	automatic

580 0	-	-	-	-	-	-
245 0	245 0	245 0	-	-	245	245
0	0	0	●	●	0	0
●	●	●	●	●	0	0
●	●	●	●	●	●	●
0	0	0	0	0	0	0
0	0	0	0	0	0	0

Facts

Usage	Mounting	Model
 Green	Rear compact (gardening)	Bromex PA
	 Multipurpose	Side Pivoting (road maintenance)
Bromex M Plus		
 Multipurpose	Rear	Bromex PM
		Bromex PX
	Front & Rear	Bromex PF
		Bromex PXD
 Agri	Rear Mounted	Bromex CJ
		Bromex CX
		Bromex CZ
	Foldable	Bromex CXF

Horse Power Rate (hp)				Blades vs Crop		
0	100	200	300	Grass Light	Various Medium	Wood Tuff

Safety devices may have been removed from the machines for illustration purposes only, in order to better present functions of the machines. To avoid risk of injury, safety devices must never be removed. If removal of safety devices is necessary, e.g. for maintenance purposes, please contact proper assistance or supervision of a technical assistant. ® = trade mark protection in the EU. © Kverneland Group Ravenna S.r.l.

Proud History of Ground Breaking Innovations

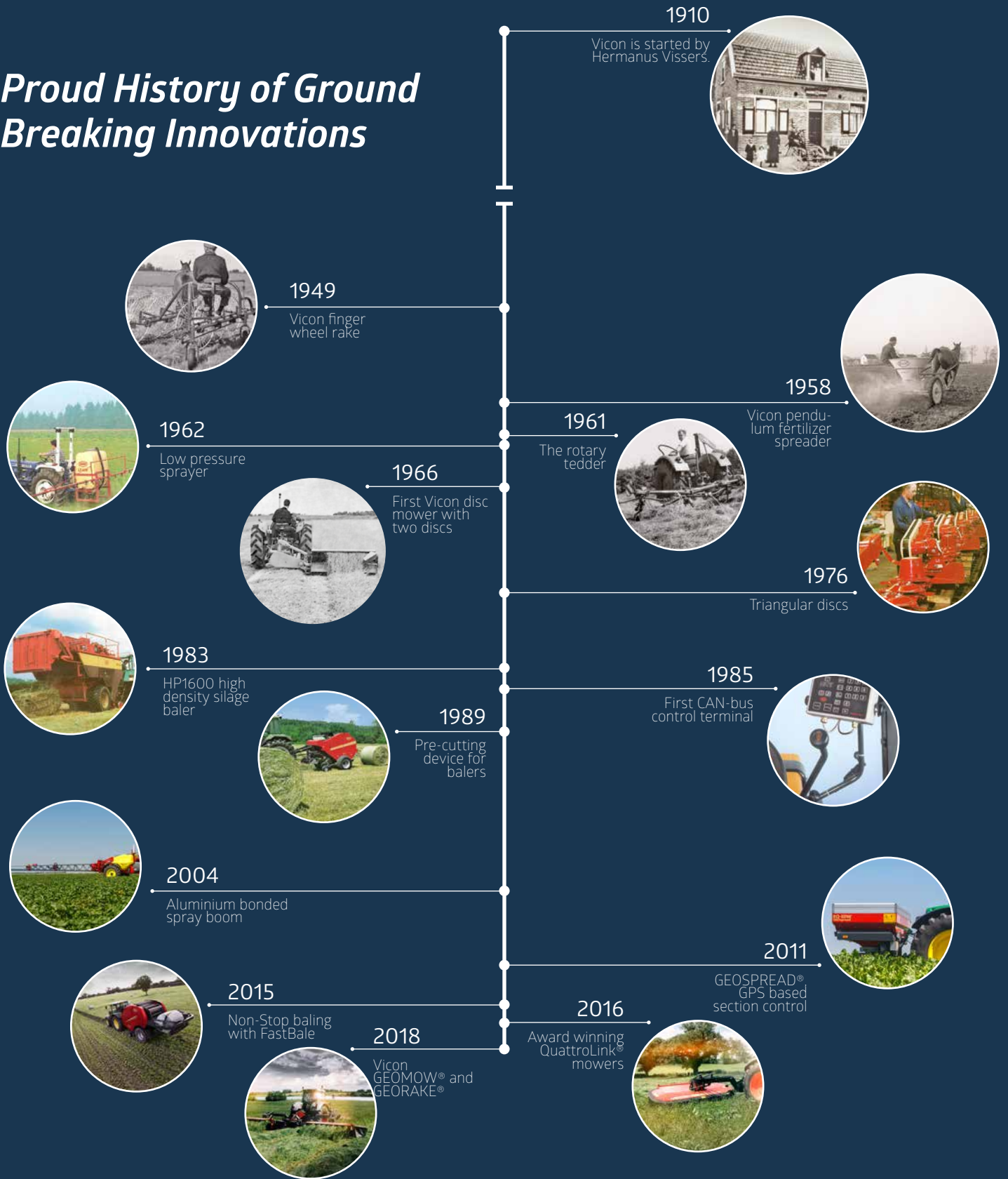

My way of Farming!



www.vicon.eu

B-0105-EN_03-2024